

KEYLESS WORLD



MOBILEKEY

Product catalogue

Digital locking solutions
for small-scale commercial
enterprises with up to 20 doors

Valid from 1 February 2024

Simons Voss
technologies

RETHINKING KEY DESIGN

Keyless locking -
with a grip on comfort and security



Electronic remote keys have long been standard features in cars. The electronic opening and closing of up to 20 doors in commercial enterprises is now possible thanks to MobileKey from SimonsVoss.

It's so easy to launch KEYLESS WORLD: MobileKey replaces your mechanical key with a digital transponder, a PIN code keypad or your smartphone. Install digital locking cylinders instead of mechanical ones. No cabling or drilling required. You configure the system with the help of a free-of-charge Web app and your new locking system is then ready to use.

This intelligent, all-inclusive solution is suitable for up to 20 doors and a maximum of 100 users. MobileKey guarantees maximum user friendliness, efficiency and profitability.

SimonsVoss has installed more than
one million locking cylinders.
When are you going to join us?

ONLINE ACCESS MANAGEMENT

Today's access control –
customised, intuitive, innovative



Would you like to track who is coming in and out of your company? Then use your internet-ready PC, your tablet or smartphone to create personalised locking plans. Just a few clicks on our Web app and you can specify when to open and close doors. The data is then transmitted to the digital door cylinders. And you're done. Lost keys again? What happens a million times over every year need not be a problem any more. If a transponder is lost, it can simply be disabled in a few seconds. It then takes just a few minutes to install a new transponder.

MOBILE KEY OFFERS ADDED COMFORT AND FUNCTIONS

// Time schedules and event logging

Time schedules enable you to decide who gains access where and when.
Event logging shows who entered rooms at what times.

// DoorMonitoring – the smallest wireless door monitoring system in the world

Integrated sensors in the cylinder monitor the door status and record each change in status. Crucial information is forwarded in real time, indicating whether the door is open or closed, the dead bolt is completely retracted or extended and if the door has been locked once or double locked or has been open too long.

// Fully automatic notifications

Automatic notifications can be sent by email or as push-message to the MobileKey app, advising of pre-defined events or alarms as part of the Event Management system.

// Key4Friends

Temporary access authorisations, e.g. for service providers or for customers and guests, can be sent by e-mail in the online version of MobileKey. Your Key4Friends is valid for up to 6 months and can be extended as often as you like.

Event management in real time and extended notification displays.
System management at any time from anywhere thanks to the MobileKey app.
Choose digital locking and choose the power to act.

A FEW CLICKS TO ACCESS THE LOCKING SYSTEM

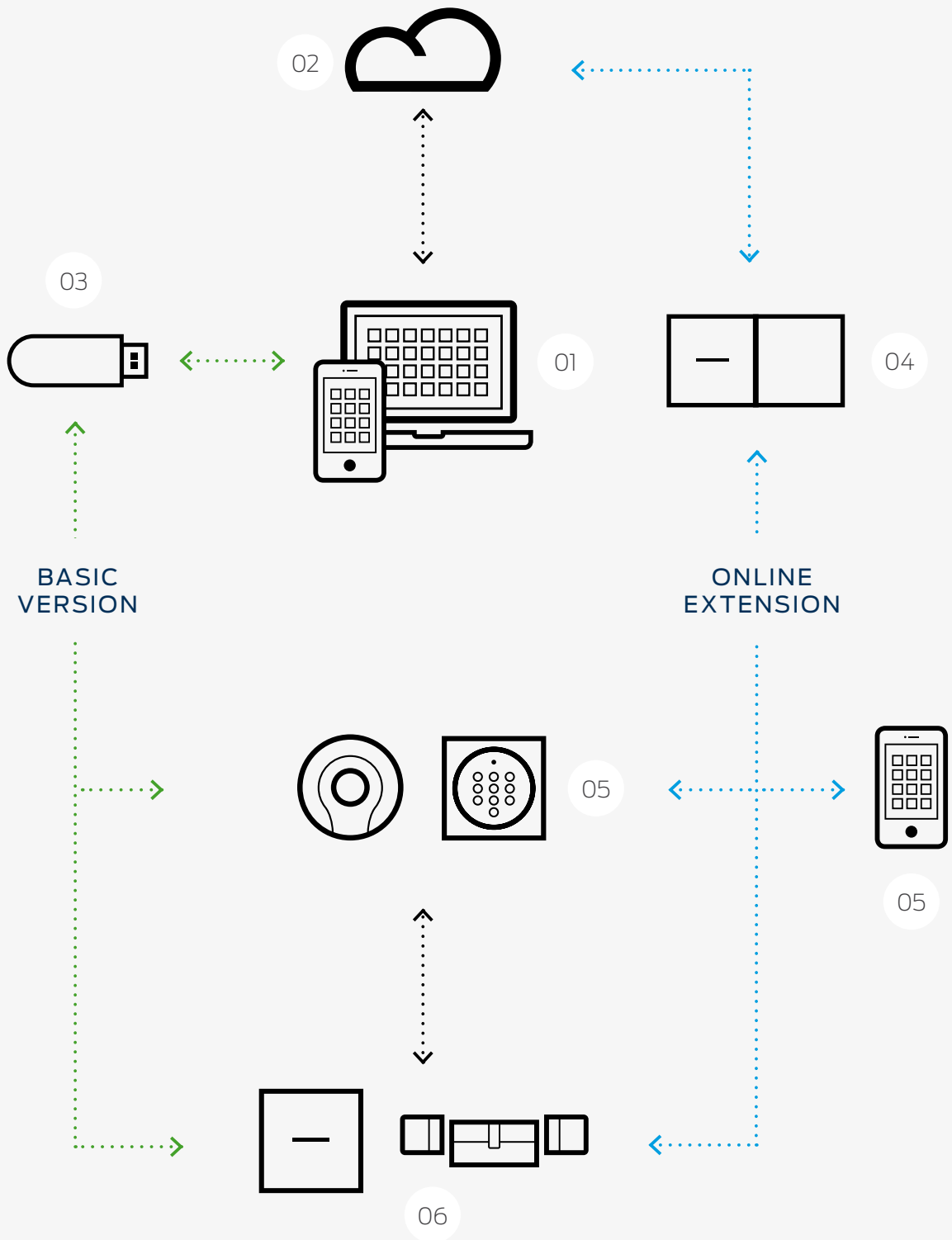

// 01. Web-App

MobileKey is set up and managed using a Web app. The app can run on any internet-ready device such as a PC, tablet PC, Mac computers or smartphone. With just a few clicks, you can assign access authorisations to specific users as you wish. This is child's play and can be changed at any time.

// 02. SimonsVoss server

The data from the Web app is transmitted to the audited SimonsVoss server where it is added as a locking plan and sent back to the Web app. Everything is automatic – you don't need to lift a finger.

// 03. Standard version

The programming device allows you to transfer data to your transponders and locking components. Your system is now ready for operation.

// 04. Optional: Online upgrade

In the online version, your networked locking components or the PIN code keypad (online) are directly connected to the server via a SmartBridge. System equipment and authorisation changes will be implemented almost in real time as a result. Full control - anywhere at any time.

// 05. Radio key as means of identification

Open up without a mechanical key, using a transponder, PIN code keypad or smartphone (online) It's that simple for you to change to the digital way of locking.

// 06. Locking components

Press the button and your wireless key transmits individual stored authorisations to the digital cylinders or a specially designed relay. Doors and gates will then open if the authorisation is valid.



// German-made security

Our high level of safety was confirmed by independent tests.

Transponders MobileKey

The transponder serves as an electronic key in the MobileKey system. Equipped with a high-performance battery, the transponder can activate up to 400,000 locking and unlocking procedures. The digital “key” contacts the electronic locking cylinder wirelessly. It will only activate if the authorisation is valid. If lost, the transponder can be disabled instantly – a new one can be configured as required at the click of the mouse

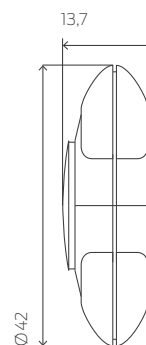

Measurements indicated in mm

Technical specifications

- :: Housing made of black polyamide
- :: Dimensions: 42x13.7 mm (ØxH)
- :: Protection rating: IP 65
- :: Typical read range: up to 40 cm to the locking cylinder
- :: Battery type: 1 x CR2032, 3 V, lithium
- :: Battery life:
 - up to 400,000 activations or up to ten years on stand-by
- :: Temperature range: -25 °C to +65 °C
- :: Environmental class: III
- :: For up to 4 locking systems MobileKey or System 3060 (G2)

Description

Order code

Transponder MobileKey with blue button

MK.TRA2.G2

Switching transponder with 2 connection wires to activate it via an isolated contact

TRA2.G2.SCHALT

PinCode keypad MobileKey

Open your doors with a 4- to 8-digit code. You can fit the ultra-slim PIN code keypad indoors or outdoors without any cabling and even mount it on glass. Save time and costs, for example by issuing a special code for the entrance door.

In the networked version (MK.PINCODE.ONLINE), user PINs can also be changed and managed online using the web app.

The keypad can be installed independently of the location of the cylinder or of a smart relay due to the radio connection with the SmartBridge. Opening is after verification on the server by the SmartBridge.

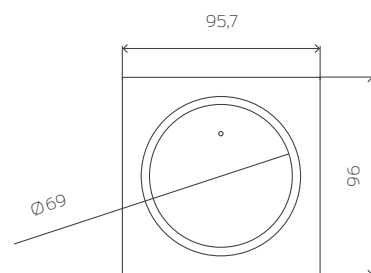

Measurements indicated in mm

Technical specifications

- :: Silver-coloured ABS plastic housing
- :: Dimensions: 96 x 95.7 x 14 mm (H x W x D)
- :: Weight: about 100 g including batteries
- :: Protection rating: IP 65
- :: Typical read range: up to 40 cm to the locking cylinder and up to 120 cm to the SmartRelay (MK.TRA.PINCODE)/ up to 30m via 868 MHz to the SmartBridge (MK.PINCODE.ONLINE)
- :: Battery type: 2 x CR2032, 3 V, lithium (MK.TRA.PINCODE)/ 4 x CR2032 3 V lithium (MK.PINCODE.ONLINE)
- :: Battery life: up to 100,000 activations or up to 10 years on stand-by (MK.TRA.PINCODE)/ up to 500,000 activations or up to 12 years on stand-by (MK.PINCODE.ONLINE)
- :: 2-level battery warning system
- :: Temperature range: -25 °C to +65 °C
- :: Number of keypad users: 3 different PINs
- :: Cable-free surface mount

Description

PinCode keypad MobileKey

Online PinCode keypad MobileKey
Version with integrated NetworkNode for networking

Order code

MK.TRA.PINCODE

MK.PINCODE.ONLINE

Measure and select the right locking cylinder.

Before ordering the locking cylinder, you need to take measurements to establish the required cylinder size. Inside and outside dimensions are required. A rule or measuring template is used to measure from the centre of the fastening screw to the end of the inlay.

The cylinders are available in length intervals of 5 mm. for example, 35 or 40 mm. The cylinder housing should close as flush as possible. For example, if you measure an external length of 38 mm, you should order a locking cylinder with an outside length of 40 mm.

If the external dimension is 40 mm and the inside dimension 35 mm, these measurements become part of the order code: MK.Z4.40-35.FD.FH.ZK.G2.

To fit the door-monitoring cylinder, an intelligent forend screw of suitable length must also be ordered, for which the backset is needed.

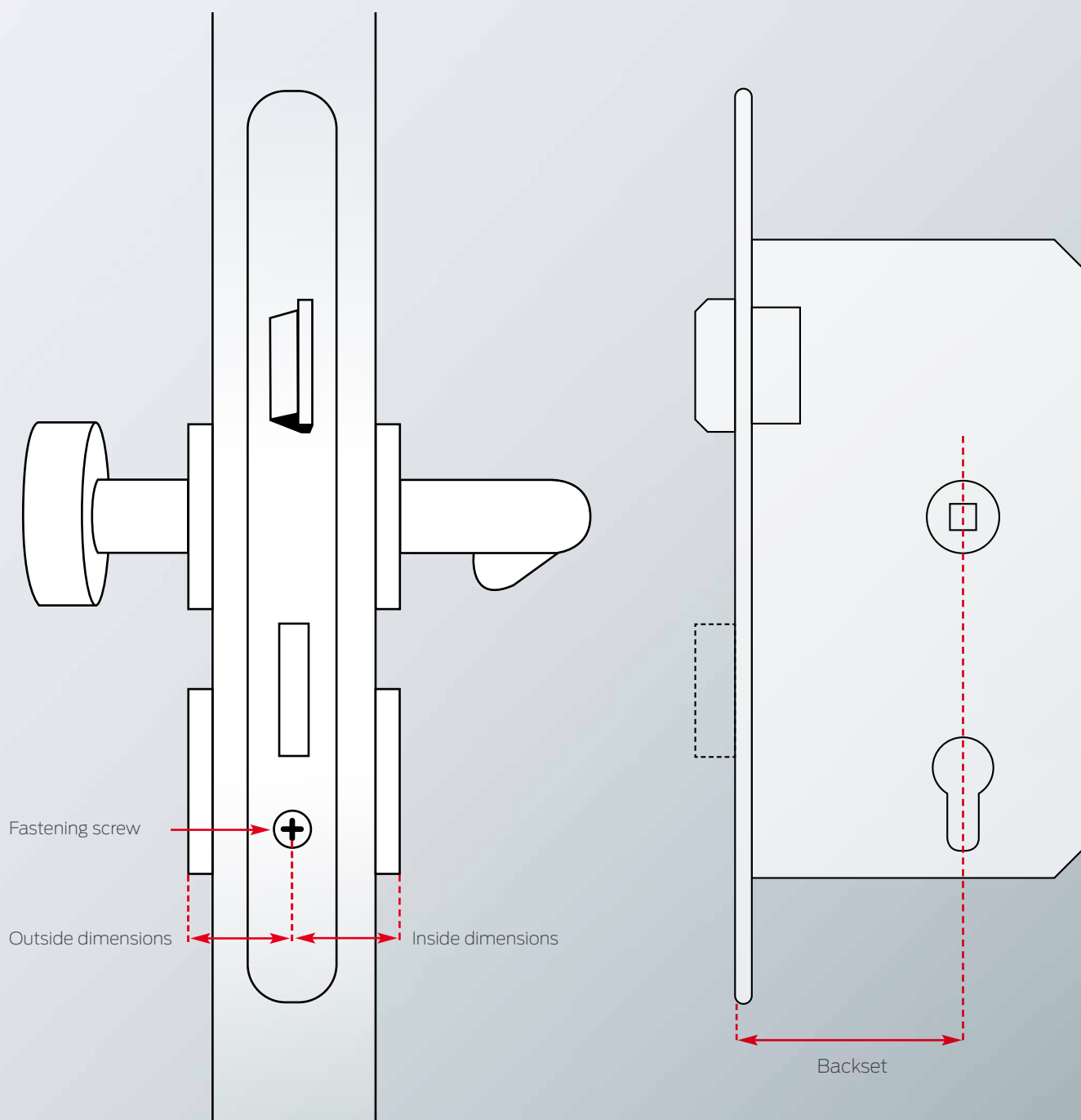

Digital Euro Profile Double Thumb-turn Cylinder MobileKey

The locking cylinder – your digital lock. Fast, cable-free installation with no drilling and a beautifully shaped design: the all-rounder for a large number of applications.

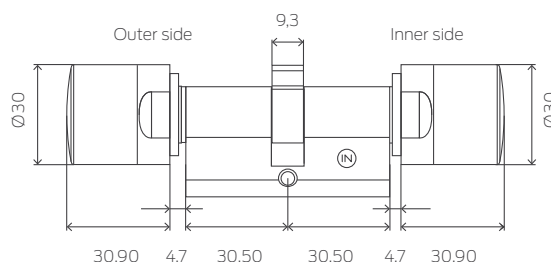

Measurements indicated in mm

Technical specifications

- ⌘ Standard Euro Profile cylinder as per DIN 18252/ EN 1303/DIN EN 15684, stainless steel thumb-turns, freely rotating on both sides
- ⌘ Thumb-turn diameter: 30 mm
- ⌘ Basic installation length: 30 – 30 mm (outer/inside dimension)
- ⌘ Overall length: up to max. 140 mm (max. 90 mm on one side), at no extra charge
- ⌘ Protection rating: IP 54; weatherproof version: IP 66
- ⌘ Battery type: 2 x lithium, CR2450, 3 V
- ⌘ Battery life: up to 300,000 locking operations or up to ten years on standby
- ⌘ Temperature range: Operational: -25 °C to +65 °C
In storage: -35 °C to +50 °C
- ⌘ 500 access events can be logged

Product versions

Order code

Digital Euro Profile Double Thumb-turn Cylinder MobileKey – FD
freely rotating on both sides; stainless steel thumb-turns
Version with integrated LockNode for networking

MK.Z4.aa-ii.FD.FH.ZK.G2

MK.Z4.aa-ii.FD.FH.LN.ZK.G2

Multi-point version for use in doors with multi-point locks;
installation length 35 – 30 mm and above
Version integrated LockNode for networking

MK.Z4.aa-ii.FD.MR.FH.ZK.G2

MK.Z4.aa-ii.FD.MR.FH.LN.ZK.G2

Weatherproof version; protection rating: IP 66;
installation length 30 – 35 mm and above,
Version with integrated LockNode for networking

MK.Z4.aa-ii.FD.WP.FH.ZK.G2

MK.Z4.aa-ii.FD.WP.FH.LN.ZK.G2

Digital Euro Profile Double Thumb-turn Cylinder MobileKey – DoorMonitoring
compact door monitoring; installation length 30 – 35 mm and above;
freely rotating on both sides, LockNode integrated for networking
(Not suitable for multi-lock systems with gears. Alternatively, see
anti-panic cylinder DM.AP2)

MK.Z4.aa-ii.DM.FD.FH.ZK.G2

Intelligent fastening screw with sensors for use with the DoorMonitoring
cylinder. You need to know the backset to order the fastening screw.
Available in 5 mm increments, from 25 mm to max. 70 mm.

Z4.DM.xx.SCREW

Digital Euro Profile Double Thumb-turn Cylinder MobileKey – Button control

The same as the standard cylinder but with added button control, thus allowing the inner side to be opened without a transponder. Particularly suitable for external and access doors.

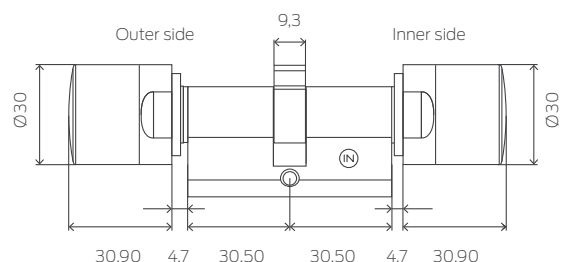

Measurements indicated in mm

Technical specifications

- :: Standard Euro Profile cylinder as per DIN 18252/EN 1303/ DIN EN 15684
- :: Thumb-turn diameter: 30 mm
- :: Basic installation length: 30 – 30 mm (outer/inside dimension)
- :: Overall length: up to max. 140 mm (max. 90 mm on one side), at no extra charge
- :: Protection rating: IP 54
- :: Battery type: 2 x lithium, CR2450, 3 V
- :: Battery life: up to 300,000 locking operations or up to ten years on standby
- :: Temperature range: Operational: -25 °C to +65 °C
In storage: -35 °C to +50 °C
- :: 500 access events can be logged

Product versions

Digital Euro Profile Double Thumb-turn Cylinder MobileKey – Button control
freely rotating on both sides; can be operated from inside without transponder; stainless steel thumb-turns
Version with integrated LockNode for networking

Multi-point version for use in doors with multi-point locks;
installation length 35 – 30 mm and above
Version with integrated LockNode for networking

Digital Euro Profile Double Thumb-turn Cylinder MobileKey – DoorMonitoring
compact door monitoring; with button control; installation length 30 – 35 mm and above; freely rotating on both sides; integrated LockNode for networking
(Not suitable for multi-lock systems with gears. Alternatively, see anti-panic cylinder DM.AP2)

Intelligent fastening screw with sensors for use with the DoorMonitoring cylinder. You need to know the backset to order the fastening screw. It can be ordered in 5 mm increments between 25 mm and 70 mm.

Order code

MK.Z4.aa-ii.FD.TS.FH.ZK.G2

MK.Z4.aa-ii.FD.TS.FH.LN.ZK.G2

MK.Z4.aa-ii.FD.TS.MR.FH.ZK.G2

MK.Z4.aa-ii.FD.TS.MR.FH.LN.ZK.G2

MK.Z4.aa-ii.DM.FD.TS.FH.ZK.G2

Z4.DM.xx.SCREW

Digital Euro Profile Double Thumb-Turn Cylinder MobileKey – Anti-panic

The anti-panic cylinder has been specially developed for use along escape and rescue routes. The AP cylinder is freely rotating on both sides, so that the lock can be locked and unlocked from both sides using an authorised transponder. In a panic situation, however, the door can be opened without a transponder using the anti-panic lock function. It may only be fitted into locks which list the cylinder in their approval.

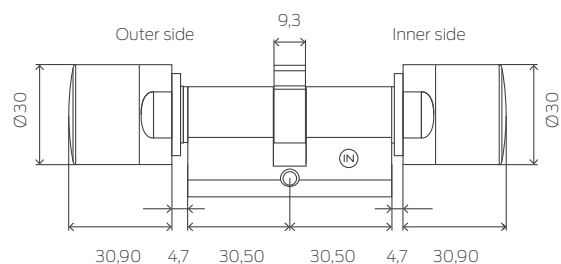

Measurements indicated in mm

Technical specifications

- :: Euro Profile Anti-panic cylinder as per DIN 18252/EN 1303/ DIN EN 15684
- :: Thumb-turn diameter: 30 mm
- :: Basic installation length: 30 – 30 mm (outer/inside dimension)
- :: Overall length: up to max. 140 mm (max. 90 mm on one side), at no extra charge
- :: Protection rating: IP 54
- :: Battery type: 2 x lithium, CR2450, 3 V
- :: Battery life: up to 300,000 locking operations or up to ten years on standby
- :: Temperature range: Operational: -25 °C to +65 °C
In storage: -35 °C to +50 °C
- :: 500 access events can be logged

Product versions

Digital Euro Profile Double Thumb-turn Cylinder MobileKey – Anti-panic
For use in anti-panic locks, freely rotating on both sides,
tainless steel thumb-turns
Version with integrated LockNode for networking

Weatherproof version; protection rating: IP 66

Version with integrated LockNode for networking

Digital Euro Profil Double thumb-turn cylinder MobileKey – Anti-panic
– DoorMonitoring; Suitable for doors which require extra surveillance,
installation length 30 – 35 mm and above, freely rotating on both sides,
with integrated LockNode for networking, without bolt detection;
applicable in all typical multi point locks

Digital Euro Profil Double thumb-turn cylinder MobileKey – Anti-panic
– DoorMonitoring; Version as described above, but with button control

Intelligent fastening screw with sensors for use with
the DoorMonitoring cylinder. (description, see previous page)

Order code

MK.Z4.aa-ii.AP2.FD.FH.ZK.G2

MK.Z4.aa-ii.AP2.FD.FH.LN.ZK.G2

MK.Z4.aa-ii.AP2.FD.FH.WP.ZK.G2

MK.Z4.aa-ii.AP2.FD.FH.WP.LN.ZK.G2

MK.Z4.aa-ii.DM.AP2.FD.FH.ZK.G2

MK.Z4.aa-ii.DM.AP2.FD.TS.FH.ZK.G2

Z4.DM.xx.SCREW

Digital Euro Profile Double Thumb-turn Cylinder MobileKey – Comfort

Comfort cylinder (electronics on the outside; to be operated from the inside without transponder as the thumb-turn is engaged.)

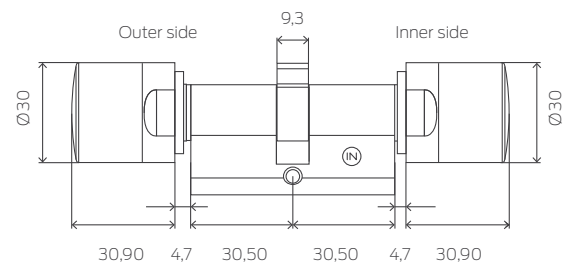

Measurements indicated in mm

Technical specifications

- :: Standard Euro Profile cylinder as per DIN 18252/EN 1303/ DIN EN 15684
- :: Thumb-turn diameter: 30 mm
- :: Basic installation length: 30 – 30 mm (outer/inside dimension)
- :: Overall length: up to max. 140 mm (max. 90 mm on one side), at no extra charge
- :: Protection rating: IP 54
- :: Battery type: 2 x lithium, CR2450, 3 V
- :: Battery life: up to 300,000 locking operations or up to ten years on standby
- :: Temperature range: Operational: -25 °C to +65 °C
In storage: -35 °C to +50 °C
- :: 500 access events can be logged

Product versions

Digital Euro Profile Double Thumb-turn Cylinder MobileKey – Comfort
Electronics on the outside; to be operated from the inside without transponder as the thumb-turn is engaged; stainless steel thumb-turns
Version with integrated LockNode for networking

Weatherproof version; protection rating: IP 66
(installation length 30 – 30 mm, thumb-turn only)
Version with integrated LockNode for networking

Order code

MK.Z4.aa-ii.CO.ZK.G2

MK.Z4.aa-ii.CO.LN.ZK.G2

MK.Z4.aa-ii.CO.WP.ZK.G2

MK.Z4.aa-ii.CO.WP.LN.ZK.G2

Digital Euro Profile Half cylinder MobileKey

You can acquire the digital locking cylinder in a wide variety of versions, including a half cylinder. It offers you a solution for all door installation types in outdoor areas, such as in garage doors or key switches.

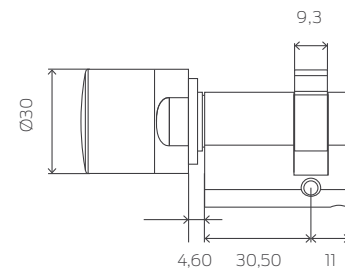

Measurements indicated in mm

Technical specifications

- :: Standard Euro Profile cylinder as per DIN 18252/ EN 1303/DIN EN 15684
- :: Thumb-turn diameter: 30 mm
- :: Basic installation length: 30 – 10 mm (outer/inside dimension) At no extra charge
- :: Overall length: up to max. 140 mm (max. 90 mm on one side), at no extra charge
- :: Protection rating: IP 66
- :: Battery type: 2 x lithium, CR2450, 3 V
- :: Battery life: up to 300,000 locking operations or up to ten years on standby
- :: Temperature range: Operational: -25 °C to +65 °C
In storage: -35 °C to +50 °C
- :: 500 access events can be logged

Product versions

Digital Euro Profile half cylinder MobileKey, weatherproof version; protection rating: IP 66 (Thumb-turn); Thumb-turn cannot be detached; stainless steel thumb-turn
Version with integrated LockNode for networking

Multi-point design; detachable Thumb-turn; weatherproof version; Protection rating: IP 66 (Thumb-turn)
Version with integrated LockNode for networking

Order code

MK.Z4.aa-10.HZ.WP.ZK.G2

MK.Z4.aa-10.HZ.WP.LN.ZK.G2

MK.Z4.aa-10.HZ.MR.WP.ZK.G2

MK.Z4.aa-10.HZ.MR.WP.LN.ZK.G2

Digital Scandinavian Oval Cylinder MobileKey

The locking cylinder can also be delivered for doors with Scandinavian Oval Profile.

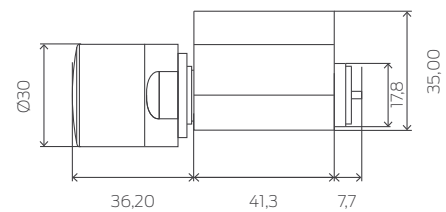

Measurements indicated in mm

Technical specifications

- :: Scandinavian Oval Profile Cylinder
- :: Diameter: 30 mm
- :: Basic installation length: in the version for the outer side: 41.3 mm; in the version for the inner side: 30 mm
- :: Overall length: max. 86.3 mm; special lengths on request
- :: Protection rating: inner thumb-turn: IP54;
weatherproof version of cylinder for the outer side: IP66
- :: Battery type: 2 x lithium, CR2450, 3V
- :: Battery life: up to 300,000 lock operations or up to ten years on standby
- :: Temperature range: Operational: -25 °C to +65 °C
In storage: -35 °C to +50 °C
- :: 500 access events can be logged

Product versions

Digital Scandinavian Oval Cylinder for the outer side,
finstallation length: 41.3 mm; stainless steel thumb-turn
Version with integrated LockNode for networking

Digital Scandinavian Oval Cylinder for the outer side,
Weatherproof version, installation length: 41.3 mm;
stainless steel thumb-turn
Version with integrated LockNode for networking

Digital Scandinavian Oval Cylinder, for the inner side

Order code

MK.Z4.SO.A40.ZK.G2

MK.Z4.SO.A40.LN.ZK.G2

MK.Z4.SO.A40.WP.ZK.G2

MK.Z4.SO.A40.WP.LN.ZK.G2

Z4.SO.I30

Digital Swiss Round Double Thumb-turn Cylinder MobileKey – Comfort

Digital locking cylinder for doors with a Swiss Round Profile.

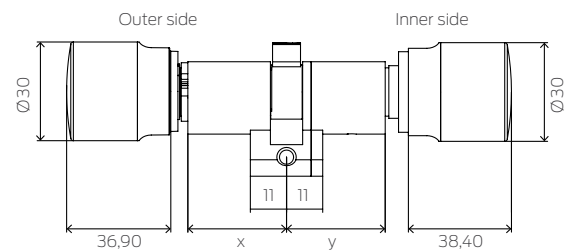

Measurements indicated in mm

Technical specifications

- :: Swiss Round Cylinder as per DIN 18252/EN 1303/ DIN EN 15684, stainless steel thumb-turns, inner thumb-turn can be operated without transponder
- :: Thumb-turn diameter: 30 mm
- :: Basic installation length: 30 – 30 mm (outer/inside dimension)
- :: Overall length: up to max. 140 mm (max. 90 mm on oneside), at no extra charge
- :: Protection rating: IP 54, weatherproof version: IP 66
- :: Battery type: 2 x lithium, CR2450, 3V
- :: Battery life: up to 300,000 lock operations or up to ten years on standby
- :: Temperature range: Operational: -25 °C to +65 °C
In storage: -35 °C to +50 °C
- :: 500 access events can be logged

Product versions

Digital Swiss Round Double Thumb-turn Cylinder MobileKey – Comfort, inside thumb-turn can be operated without transponder, stainless steel thumb-turns
Version with integrated LockNode for networking

Weatherproof version, protection rating IP 66

Version with integrated LockNode for networking

Order code

MK.Z4.SR.aa-ii.CO.ZK.G2

MK.Z4.SR.aa-ii.CO.LN.ZK.G2

MK.Z4.SR.aa-ii.CO.WP.ZK.G2

MK.Z4.SR.aa-ii.CO.WP.LN.ZK.G2

Digital Swiss Round Half Cylinder MobileKey

Suitable e.g. for garage doors or use with key-operated switches.

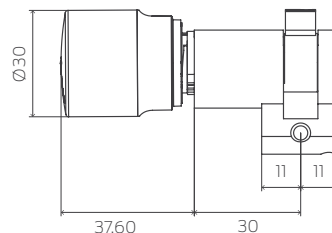

Measurements indicated in mm

Technical specifications

- :: Swiss Round half cylinder as per DIN 18252/EN 1303/ DIN EN 15684
- :: Detachable thumb-turn
- :: Thumb-turn diameter: 30 mm
- :: Multi-point version: 35 – 10 mm
- :: Basic installation length: 30 – 10 mm
- :: Overall length: up to max. 100 mm (max. 90 mm on one side), at no extra charge
- :: Protection rating: IP 66
- :: Battery type: 2 x lithium, CR2450, 3 V
- :: Battery life: up to 300,000 locking operations or up to ten years on standby
- :: Temperature range: Operational: -25 °C to +65 °C
In storage: -35 °C to +50 °C
- :: 500 access events can be logged

Product versions

Digital Swiss Round Half Cylinder MobileKey, Weatherproof version, protection rating IP 66 (thumb-turn), detachable thumb-turn, stainless steel thumb-turn
Version with integrated LockNode for networking

Multi-point version, detachable thumb-turn, Weatherproof version

Version with integrated LockNode for networking

Order code

MK.Z4.SR.aa-10.HZ.WP.ZK.G2

MK.Z4.SR.aa-10.HZ.WP.LN.ZK.G2

MK.Z4.SR.aa-10.HZ.MR.WP.ZK.G2

MK.Z4.SR.aa-10.HZ.MR.WP.LN.ZK.G2

Digital SmartRelay MobileKey

The Digital SmartRelay acts as an access control reader or key switch. In the MobileKey system, it opens electrically operated doors, gates and barriers and switches lighting, heating and machines.

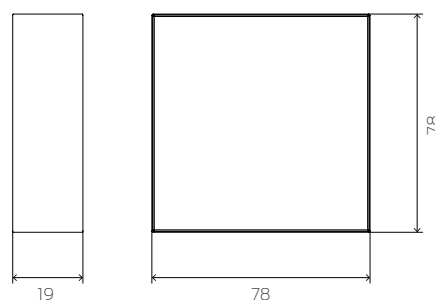

Measurements indicated in mm

Technical specifications

- :: Housing made of white polyamide 6.6
- Dimensions: 78 x 78 x 19 mm (H x W x D)
- :: Protection rating: IP 20, not suitable for unprotected use outdoors
- :: Typical read range: up to 120 cm
- :: Temperature range: Operational: -22 °C to +55 °C
- :: Air humidity: < 95 % without condensation
- :: Circuit board dimensions: 50 x 50 x 14 mm (H x W x D)
- :: Mains voltage: 5–24 V DC
- :: Power limitation: mains adapter must be limited to 15 VA
- :: Standby current: < 5 mA
- :: Max. current: < 100 mA
- :: Pulse duration can be programmed between 1 and 25 sec.
- :: 500 access events can be logged

Product versions

Digital SmartRelay MobileKey in white design housing for surface mount; connection for external antenna
Version with integrated LockNode suitable for networking

Technical specifications for output relay

- :: Type: changeover contact; in SREL2: normally open contact invertible
- :: Continuous current: max. 1.0 A
- :: Switch-on current: max. 2.0 A
- :: Switching voltage: max. 24 V
- :: Switching power: 10⁶ activations at 24 VA

Order code

MK.SREL2.ZK.G2.W

MK.SREL2.LN.ZK.G2.W

Digital SmartRelay MobileKey

The Digital SmartRelay acts as an access control reader or key switch. In the MobileKey system, it opens electrically operated doors, gates and barriers and switches lighting, heating and machines.

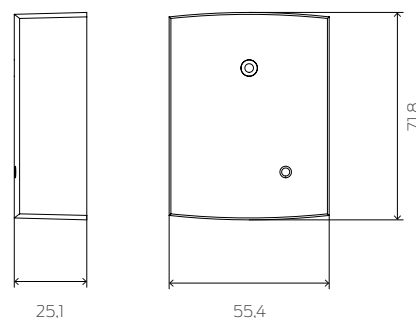

Measurements indicated in mm

Technical specifications

- ⌘ Housing made of black plastic (polyamide 6.6)
- ⌘ Dimensions: 55.4 x 71.8 x 25.1 mm (H x W x D)
- ⌘ Protection rating: IP 20, not suitable for unprotected use outdoors
- ⌘ Typical read range: up to 120 cm
- ⌘ Temperature range: Operational: -22 °C to +55 °C
- ⌘ Air humidity: < 95 % without condensation
- ⌘ Circuit board dimensions: 50 x 50 x 14 mm (H x W x D)
- ⌘ Mains voltage: 12 V AC or 5–24 V DC
- ⌘ Power limitation: mains adapter must be limited to 15 VA
- ⌘ Standby current: < 5 mA
- ⌘ Max. current: < 100 mA
- ⌘ Pulse duration can be programmed between 1 and 25 sec.
- ⌘ Battery operation optional
- ⌘ 500 access events can be logged

Product versions

Digital SmartRelay MobileKey in black housing also suitable for flush-fit; connection possible for external antenna

Technical specifications for output relay

- ⌘ Type: changeover contact; in SREL2: normally open contact invertible
- ⌘ Continuous current: max. 1.0 A
- ⌘ Switch-on current: max. 2.0 A
- ⌘ Switching voltage: max. 24 V
- ⌘ Switching power: 10⁶ activations at 24 VA

Order code

MK.SREL.ZK.G2

Digital padlock MobileKey

Digital padlock with 8 mm shackle diameter
To secure gates, grilles and other locks with eyelets or via an additional chain

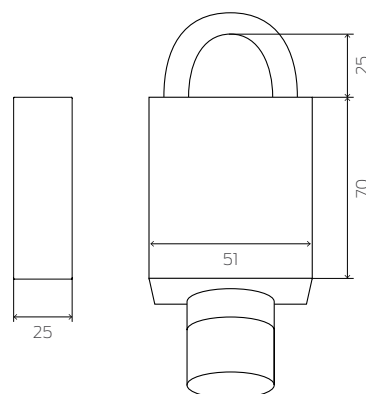

Measurements indicated in mm

Technical specifications

- :: Dimensions of lock without cylinder thumb-turn and without shackle 51x70x25 mm (BxHxT)
- :: Shackle internal height: 25 mm
- :: Thumb-Turn diameter: 30 mm
- :: Housing protection class Class 3 as per EN 12320
- :: Protection rating: IP66
- :: Battery type: 2 x CR2450 3V lithium

- :: Battery life:
Up to 300,000 operations or 10 years on standby
- :: Temperature range:
Operational: -25 °C to +55 °C
In storage: -45 °C to +70 °C
- :: Up to 500 accesses can be stored

Product versions

Shackle inner height 25 mm, self-locking

Construction with integrated LockNode for networking

Order code

MK.Z4.PL.08.25.SL.WP.ZK.G2

MK.Z4.PL.08.25.SL.WP.LN.ZK.G2

Accessories

Safety chain for padlocks with 8 mm shackle diameter, length c.30 cm

Wall bracket for safety chain

Order code

PL.CHAIN.08.30

PL.CHAIN.BRACKET

USB programming device

MobileKey

The small, compact USB programming device allows operators of small and extremely small lock systems to have absolute control over their lock system. It enables them to create a locking system, programme components and manage access authorisations. The USB programming device is provided together with an easy-to-use MobileKey web application.



Technical specifications

- :: Programming: SimonsVoss 25 kHz technology
- :: Operating system: Windows 7 and higher, macOS, Android (Smartphone)
- :: USB port: USB type A (same as a flash memory)/ USB 2.0
- :: Power supply: USB connector
- :: Dimensions: 57 (70) x 19 x 13 mm (L x W x H)
- :: Programming distance: 10–30 cm
- :: Protection rating: IP 40
- :: Temperature range: -10 °C to +60 °C
- :: Humidity: 95 % (non-condensing)

Description

USB programming device to programme MobileKey products. Connection to a PC via USB port in conjunction with MobileKey web application

Order code

MK.CD.STARTER.G2

Starter sets

We also offer MobileKey components in affordable starter kits for new users.



MobileKey Starter Set 1

Order code

Consisting of 3 transponders (MK.TRA2.G2)
and 1 USB config device (MK.CD.STARTER.G2)

MK.SET1

MobileKey Starter Set 2

Order code

Consisting of 3 transponders (MK.TRA2.G2)
1 PinCode keypad (MK.TRA .PINCODE) and
1 USB config device (MK.CD.STARTER.G2)

MK.SET2

Online extension MobileKey

In the online version, your digital locking cylinder is directly connected to the server via a SmartBridge. This allows you to install system equipment and make changes to authorisations almost in real time. Full control anywhere at any time.

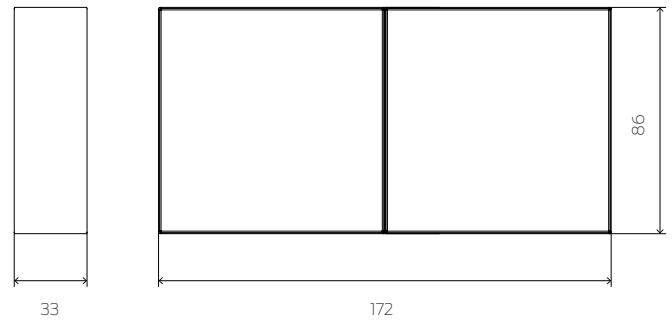

Measurements indicated in mm

Technical specifications

- :: Housing made of ABS plastic. UV-stable; colour: 9/118645, same as RAL 9016 (Traffic white)
- :: Dimensions: 172x86x33 mm (LxWxH)
- :: Radio frequency: 868.xx – 870 MHz
- :: Output: max. 3 VA
- :: Range up to 30 m
- :: Radio module transmission power: 10 dBm (6.3 mW) to the antenna socket
- :: External power supply: regulated mains adapter* 9–24 V DC PoE-capable (802.3af)

* Power supply and network cable not included

Description

MobileKey SmartBridge to network MobileKey locking devices with the SimonsVoss server. Ethernet design to connect with a network node

Order code

MK.SMARTBRIDGE.ER

What goes with it

Description	Order code
Intelligent fastening screw with sensors for use with the DoorMonitoring cylinder. IMPORTANT: you need to know the backset to order the intelligent fastening screw. Available in 5 mm increments, from 25 mm to max. 70 mm.	Z4.DM.xx.SCREW
Special mounting screwdriver for DoorMonitoring	Z4.DM.SCREWDRIVER
Installation/battery key: Special tool for disassembly and battery replacement (button cells) in TN4 cylinders (double thumb-turn cylinders and half cylinders)	Z4.SCHLUESSEL
Core protection adapter for all freely-rotating TN4 double thumb-turn cylinders; (note: take extension into account for the cylinder's external dimensions)	
8 mm extension	Z4.KA
15 mm extension	Z4.KA.15R
20 mm extension	Z4.KA.20R
5 batteries for MobileKey transponder (type: CR2032)	TRA.BAT
10 batteries for MobileKey cylinders (double thumb-turn and half cylinders) (type: CR2450)	Z4.BAT.SET
Battery for SmartRelay in black housing (MK.SREL.ZK.G2), for operating without external power supply (e.g. as door strike), Battery type: lithium 1/2 AA	SREL.BAT
External antenna for connecting Smart Relay; cable 5 m long	SREL.AV
Protective housing for SmartRelay (SREL2) for use outdoors	SREL2.COVER1
External plug-in power supply (Europlug) for SmartBridge (suitable for use with MK.SREL/MK.SREL2)	POWER.SUPPLY.2
External plug-in power (universal plug EU, US, UK, AU) for SmartBridge (suitable for use with MK.SREL/MK.SREL2)	POWER.SUPPLY.2.UNI
External antenna set for SmartBridge	ANTENNA.EXT.868
MobileKey Network thumb-turn Cover as a replacement part for networking cylinders directly	MK.LN.I
Network-thumb-turn cover MobileKey in brass for the direct networking of the cylinders	MK.LN.I.MS
MobileKey network circuit board as a replacement part for networking SmartRelay (SREL2) directly	MK.LN.I.SREL2.G2
Empty sample box (aluminium box 327 x 200 x 54) for 1 cylinder in installation length 35 – 35 mm, 2 transponders, 1 PinCode keypad, 1 USB config device	MK.KOFFER.SMALL.U

MANY BENEFITS PROVIDE THE BEST ARGUMENTS

SimonsVoss has installed more than 1 million digital locking cylinders. When are you going to join us?



State-of-the-art remote keys

Conventional keys have had their day in the MobileKey system. Open your doors with just one transponder, a PIN code keypad or from your smartphone.

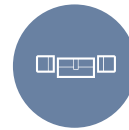

More than just locking

Time schedules determine who gains entry through each specific access at particular times. You can see on your PC who entered rooms and at what times.



No more problems due to lost keys

If you have lost your transponder, you can simply deactivate it and activate a new one. The best thing is that there is no more need to change locking devices.



Simple installation, easy retrofit

The mechanical door cylinder is simply replaced with the digital cylinder. It can be installed in a matter of minutes. No wiring, no drilling, no dirt!



Intuitive Web app and programming

You can learn how to use the Web app in just a few minutes and then configure everything yourself.



Excellent cost efficiency

MobileKey® is inexpensive and extremely low maintenance. It is suitable for systems with 20 doors and up to 100 users.



Completely flexible thanks to Web management

You can use MobileKey with any internet- ready device from anywhere in the world to manage the system, add or deactivate users, change authorisations or query door statuses.



Total package

You are welcome to order the measurement of door cylinders, the installation and set-up and management of your locking plan, including programming via your specialist dealer as a service.

A BESPOKE LOCKING SYSTEM IN JUST A FEW STEPS



01. Establish what components are required

First define the desired circle of users and thus the required number of identification media. Then specify how many doors you wish to fit with locking components. Next indicate the locking cylinder lengths and functions.

02. Create the locking plan on www.simons-voss.com

Register on www.simons-voss.com to activate your user account. You will then have access to the locking plan on all your Internet-ready devices. Now use the set-up agent to create the locking plan and enter component identifiers and characteristics. You can add more keys and locks whenever you like.

03. Programme the components

You can start programming as soon as the individual components have been added and the access rights for the locking components have been issued. You can use the programming device to complete programming tasks directly on any Windows computer, Apple Mac or Android smartphone. The online extension allows you to also programme networked components directly via the network.

04. Fit the components

Once the programming process is complete, you fit the locking cylinders and also SmartRelays to activate barriers, garage doors and other such installations.

05. A short functions test and you are finished!

After a short functions test the electronic lock system is ready for operation! You can change authorisations and extend your system whenever you like.



This is SimonsVoss

SimonsVoss, the pioneer in remote-controlled, cable-free locking technology provides system solutions with a wide range of products for SOHOs, SMEs, major companies and public institutions. SimonsVoss locking systems combine intelligent functionality, high quality and award-winning design Made in Germany. As an innovative system provider, SimonsVoss focuses on scalable systems, high security, reliable components, powerful software and simple operation. As such, SimonsVoss is regarded as a technology leader in digital locking systems. Our commercial success lies in the courage to innovate, sustainable thinking and action, and heartfelt appreciation of employees and partners.

SimonsVoss is a company in the ALLEGION Group, a globally active network in the security sector. Allegion is represented in around 130 countries worldwide (www.allegion.com).

Made in Germany

SimonsVoss is truly committed to Germany as a manufacturing location: all products are developed and produced exclusively in Germany.

SimonsVoss Technologies GmbH

FeringasträÙe 4
85774 Unterföhring
Germany
Tel. +49 89 992280
info-simonsvoss@allegion.com
www.simons-voss.com/en | www.allegion.com
www.my-mobilekey.com

For general safety and maintenance information, visit www.simons-voss.com/en/security.html

PK.MK.EN – 2023.11

© Copyright 2023, SimonsVoss Technologies GmbH, Unterföhring, Germany.
All rights are reserved. Text, images and diagrams are protected under copyright law.
The contents of this brochure must not be copied, distributed or modified. You can find authoritative, detailed technical information in the system manual. Subject to technical changes.
SimonsVoss and MobileKey are registered brands belonging SimonsVoss Technologies GmbH.

SimonsVoss
technologies

A BRAND OF **ALLEGION** 

Made in Germany